

GFM-C Series

GFM-1500C 2V1500Ah

GFM-C series VRLA battery uses latest AGM technology, high purity raw materials and many patented technologies that ensure its long floating and cycle life, it is applicable to less frequency of power failure, and shallow discharge of depth site. It is mainly used for indoor telecommunication base station.



Benefits

- Long life according to EUROBAT Classification
- High discharge performance
- 99%+ gas recombination efficiency
- Maximum charge efficiency
- Low self-discharge rate
- Vertical installation

Applications

- Telecommunications
- Power system
- UPS
- Emergency power

Drawing

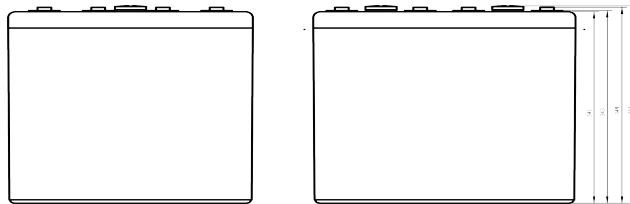

Standards

- IEC 60896-21/22
- JIS C8704-1/2
- EUROBAT guide

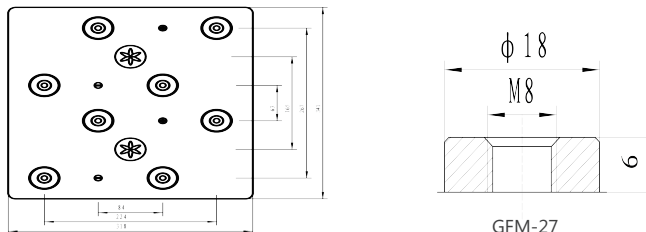

GFM-27

Specifications

Battery Model	GFM-1500C			
Design Life (years, 25°C)	15			
Capacity (Ah, 25°C)	10HR (150A, 1.80V)	5HR (258A, 1.80V)	3HR (382A, 1.80V)	1HR (825A, 1.75V)
	1500	1275	1125	825
Dimensions (mm)	Length	Width	Height	Total Height
	318	341	341	351
Approx. Weight (kg)	88.1			
Reference Internal Resistance (mΩ)	0.16(fully charged @ 25°C)			
Maximum Discharge Current (A/5 Sec.)	7500			
Self-Discharge (25°C)	≤ 1.5% per months			
Charge Voltage (V/cell, 25°C)	Cycle use		Float use	
	2.35 (-3.5mV/°C/cell), max charge current: 225A		2.25 (-3.5mV/°C/cell)	
Short Circuit Current (A)	11500			

Discharge Data

Constant Current Discharge Data (25°C, A)															
End Voltage (V/cell)	min							h							
	5	10	15	20	30	40	50	1	1.5	2	3	5	8	10	24
1.60	3150	2433	2014	1733	1376	1153	999	870	667	542	400	268	185	155	66.1
1.65	2864	2228	1861	1615	1298	1098	958	855	651	533	394	264	183	153	65.7
1.70	2615	2045	1721	1505	1223	1044	917	830	635	523	388	261	182	152	65.3
1.75	2287	1884	1621	1434	1182	1016	896	825	625	514	382	258	180	151	64.9
1.80	2008	1744	1530	1368	1138	982	869	786	607	502	375	255	178	150	64.4

Constant Power Discharge Data (25°C, W/cell)															
End Voltage (V/cell)	min							h							
	5	10	15	20	30	40	50	1	1.5	2	3	5	8	10	24
1.60	4590	3945	3327	2945	2317	1943	1718	1530	1191	984	731	495	356	297	133
1.65	4217	3582	3048	2716	2153	1830	1634	1478	1145	950	711	486	352	292	131
1.70	3722	3282	2835	2540	2009	1735	1546	1435	1116	925	696	480	347	289	129
1.75	3335	3035	2642	2361	1884	1630	1476	1368	1085	901	682	471	343	286	127
1.80	3065	2785	2421	2175	1766	1540	1423	1306	1052	877	668	463	338	283	125

Rack Layout

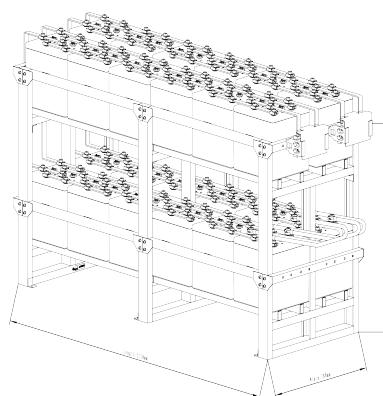

48V Standard Rack (Anti-seismic rack is optional)
 Rack material: powder-coated steel
 Height*width: 2*2
 Ref. GFM-1500C Rack (approx. weight: 2372kg)

Performance Curve

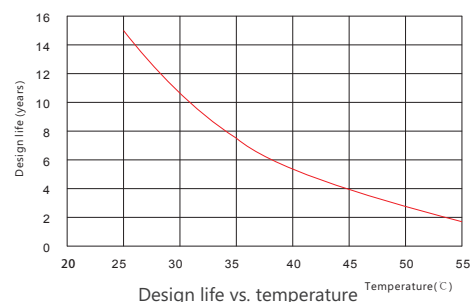
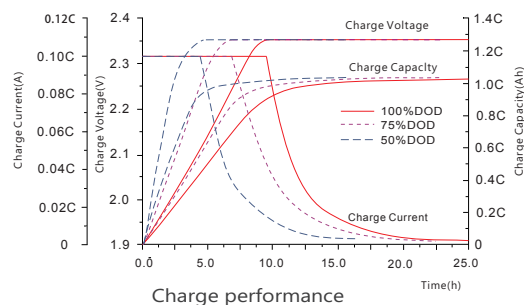
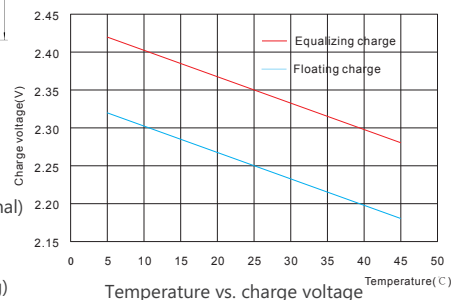
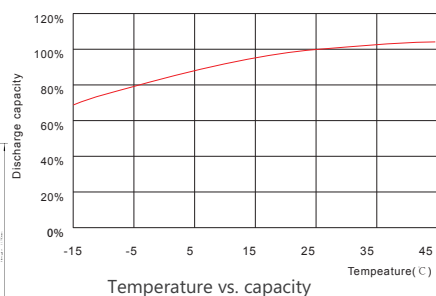

Sacred Sun Power Sources Co., Ltd.

No.1 Shengyang Road Qufu City, PRC
 sales@sacredsun.cn

Sacred Sun Asia Pacific

No. 15, Yishun Industrial Street 1,
 #01-17, WIN5, Singapore 768091
 sales.asia@sacredsun.cn

Sacred Sun Europe SPRL

Schoenstraat 96-9140 Temse, Belgium
 sales.eu@sacredsun.cn

Sacred Sun MEA FZE

S10122A1019 Jebel Ali, Dubai,
 United Arab Emirates
 sales.mea@sacredsun.cn

